

LED Light Fittings BAT86 Series Explosion-proof LED Floodlights

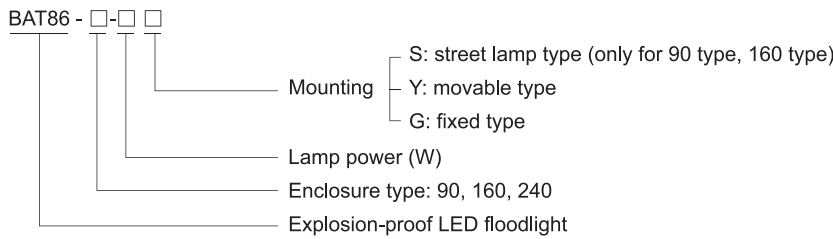

- ◆ Explosion protection to
 - CENELEC
 - IEC
 - NEC
- ◆ Can be used in
 - Zone 1 and Zone 2
 - Zone 21 and Zone 22
 - Class I, Zone 1 and Zone 2
 - Class I, Division 1, Groups B, C, D
- ◆ Three enclosure types: 90, 160, 240
- ◆ Applicable lamp and power (max.240W)
LED: 60W, 90W, 120W, 160W, 200W, 240W
- ◆ Isolated LED lamp compartment, CC-CV (constant current-constant voltage) power controller compartment and terminal compartment; Wind-convection heat dissipation structure.
- ◆ Standard product is of floodlight effect, lens of 40° and 60° can be provided on request to realize spotlight effect
- ◆ Low-maintenance due to long service life of up to 100,000 operating hours.

■ Catalogue number logic



■ Selection table

Type / Ordering code	Lamp power(W)	Weight (kg)	Type / Ordering code	Lamp power(W)	Weight (kg)	Type / Ordering code	Lamp power(W)	Weight (kg)
BAT86-90-60G	60	6.70	BAT86-90-60Y	60	8.50	BAT86-90-60S	60	7.55
BAT86-90-90G	90	6.70	BAT86-90-90Y	90	8.50	BAT86-90-90S	90	7.55
BAT86-160-120G	120	8.40	BAT86-160-120Y	120	10.20	BAT86-160-120S	120	9.25
BAT86-160-160G	160	8.40	BAT86-160-160Y	160	10.20	BAT86-160-160S	160	9.25
BAT86-240-160G	160	34.00	BAT86-240-160Y	160	35.70			
BAT86-240-200G	200	35.00	BAT86-240-200Y	200	36.50			
BAT86-240-240G	240	35.00	BAT86-240-240Y	240	36.50			

Note: 1. The product is supplied according to "Type/Ordering code" in the table with mounting accessories.
2. The light fittings are supplied without lens. Lighting distribution is of floodlight. Lens of 40° and 60° can be provided on request. Please specify when ordering.

Zones 1&2; 21&22

LED Light Fittings

BAT86 Series Explosion-proof LED Floodlights

Technical data	
Explosion-proof LED floodlights BAT86-90-□□	
Explosion protection	
Gas explosion protection	⊕ II 2 G Ex db IIB+H ₂ T6/T5 Gb
Dust explosion protection	⊕ II 2 D Ex tb IIIC T80°C/T95°C Db IP65
Certificates	EPT 15 ATEX 2300X; IECEX CQM 15.0033X; KZ.7500525.22.01.00380 (CU-TR)
Conformity to standards	EN 60079-0, EN 60079-1, EN 60079-31 IEC 60079-0, IEC 60079-1, IEC 60079-31
Material	
Enclosure	Copper-free aluminium, powder coated surface, yellow (RAL1021)
Glass cover	Toughened glass, stands 4J impact
LED driver	Wide voltage input, CC-CV (constant current - constant voltage) output, power factor ≥ 0.95 , with function of distributed current, constant current, surge-proof and anti-electromagnetic interference, and protection against overcurrent, open circuit, and short circuit
Exposed fastener	Stainless steel
Lamp	
Lamp specification	LED module, Multiple LED
Lamp power (W)	60W, 90W (50W and 70W are optional)
Colour Temperature (CCT)	Cool white: 5400~6500K Note: cool white is available in general. Warm white (2700~3500K) or nature white (4700~5400K) is optional, please specify when ordering.
Rated voltage	100~300V AC 50/60Hz
Earthing protection	M5 (internal & external earth bolts)
Degree of protection	IP65
Ambient temperature	T6/T80°C for Tamb: -40°C~+40°C T5/T95°C for Tamb: -40°C~+55°C
Terminal	3 x 1.5~4mm ² (L+N+PE)
Mounting	Movable type, fixed type, street lamp type
Cable entries	2 x M25 x 1.5 plugs
Cable gland	DQM-II (Ex d) or DQM-III (Ex d) is recommended. Please see P7/20~29



Dimension drawings (all dimensions in mm) - subject to alteration

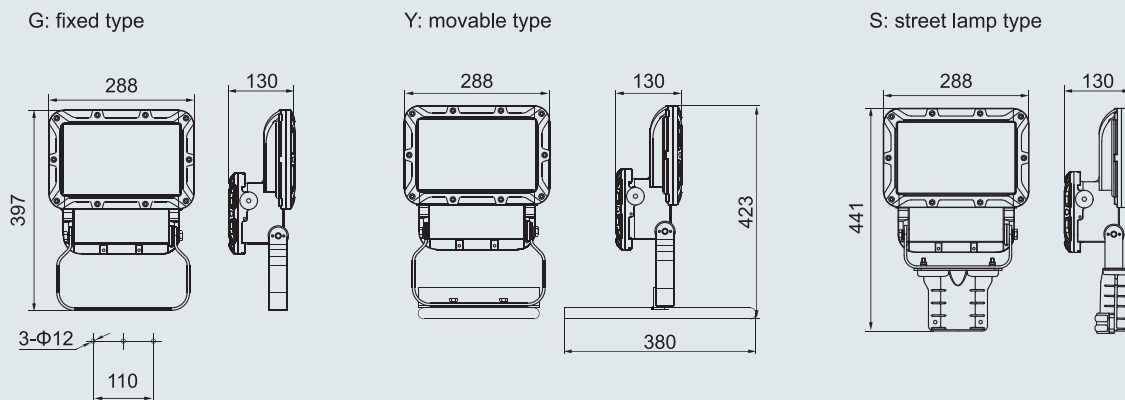

LED Light Fittings

BAT86 Series Explosion-proof LED Floodlights

Technical data

Explosion-proof LED floodlights BAT86-160-□□

Explosion protection

Gas explosion protection
Dust explosion protection

⊕ II 2 G Ex d IIB T□¹⁾ Gb
⊕ II 2 D Ex tb IIIC T□¹⁾ Db IP66

¹⁾ See Ambient temperature

Certificates

LCIE 14 ATEX 3023X; IECEx CQM 14.0008X; KZ.7500525.22.01.00380 (CU-TR)

Conformity to standards

EN 60079-0, EN 60079-1, EN 60079-31
IEC 60079-0, IEC 60079-1, IEC 60079-31

Material

Enclosure
Glass cover
LED driver

Copper-free aluminium, powder coated surface, yellow (RAL1021)

Toughened glass, stands 4J impact

Wide voltage input, CC-CV (constant current - constant voltage) output, power factor ≥ 0.95 , with function of distributed current, constant current, surge-proof and anti-electromagnetic interference, and protection against overcurrent, open circuit, and short circuit

Exposed fastener

Stainless steel

Lamp

Lamp specification
Lamp power (W)
Colour Temperature (CCT)

LED module, Multiple LED

120W, 160W (100W is optional)

Cool white: 5400~6500K

Note: cool white is available in general. Warm white (2700~3500K) or nature white (4700~5400K) is optional, please specify when ordering.

Rated voltage

100~300V AC 50/60Hz

Earthing protection

M5 (internal & external earth bolts)

Degree of protection

IP66, IP67(optional)

Ambient temperature

120W T6/T80°C for Tamb: -40°C~+40°C
160W T5/T95°C for Tamb: -40°C~+40°C
120W T5/T95°C for Tamb: -40°C~+55°C
160W T4/T130°C for Tamb: -40°C~+55°C

Terminal

3 x 1.5~4mm² (L+N+PE)

Mounting

Movable type, fixed type, street lamp type

Cable entries

2 x M25 x 1.5 plugs

Cable gland

DQM-II (Ex d) or DQM-III (Ex d) is recommended. Please see P7/20~29



Dimension drawings (all dimensions in mm) - subject to alteration

G: fixed type

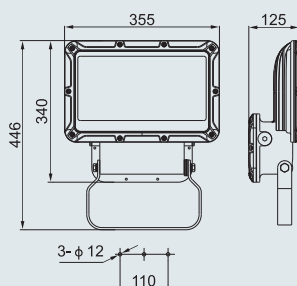

Y: movable type

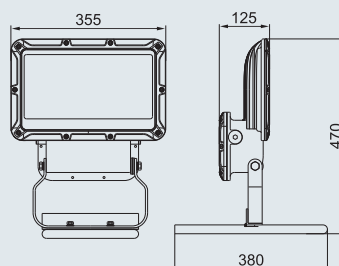

S: street lamp type

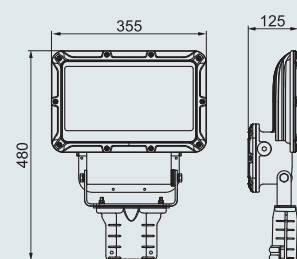

LED Light Fittings

BAT86 Series Explosion-proof LED Floodlights



Technical data	
Explosion-proof LED floodlights BAT86-240-□□	
Explosion protection	
Gas explosion protection	⊕ II 2 G Ex db op is IIB+H ₂ T□ ¹⁾ Gb
Dust explosion protection	⊕ II 2 D Ex tb op is IIIC T□ ¹⁾ Db IP66
Certificates	ATEX and IECEx (applied for)
Conformity to standards	EN 60079-0, EN 60079-1, EN 60079-28, EN 60079-31 IEC 60079-0, IEC 60079-1, IEC 60079-28, IEC 60079-31
Material	
Enclosure	Copper-free aluminium, powder coated surface, yellow (RAL1021)
Glass cover	Toughened glass, stands 4J impact
LED driver	Wide voltage input, CC-CV (constant current - constant voltage) output, power factor ≥ 0.95, with function of distributed current, constant current, surge-proof and anti-electromagnetic interference, and protection against overcurrent, open circuit, and short circuit
Exposed fastener	Stainless steel
Lamp	
Lamp specification	LED module, Multiple LED
Lamp power (W)	160W, 200W, 240W
Colour Temperature (CCT)	Cool white: 5400~6500K Note: cool white is available in general. Warm white (2700~3500K) or nature white (4700~5400K) is optional, please specify when ordering.
Rated voltage	100~277V AC 50/60Hz, 130~250V DC
Earthing protection	M5 (internal & external earth bolts)
Degree of protection	IP66, IP67(optional)
Ambient temperature	160W T6/T80°C for Tamb: -40°C~+55°C 200W/240W T5/T95°C for Tamb: -40°C~+55°C 200W/240W T6/T80°C for Tamb: -40°C~+40°C
Terminal	3 x 1.5~4mm ² (L+N+PE)
Mounting	Movable type, fixed type
Cable entries	2 x M25 x 1.5 plugs
Cable gland	DQM-II (Ex d) or DQM-III (Ex d) is recommended. Please see P7/20~29

Dimension drawings (all dimensions in mm) - subject to alteration

G: fixed type

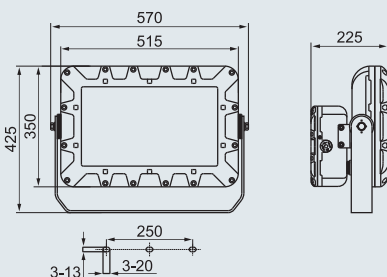

Y: movable type

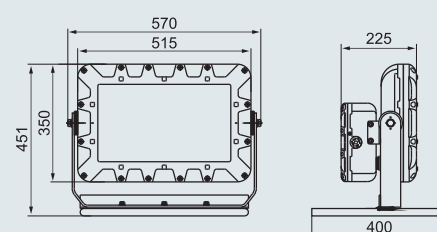

LED Light Fittings BAT86 Series Explosion-proof LED Floodlights

Photometric data Note: LED luminous flux is from the standard product of which colour temperature is 5400 to 6500K (cool white).

BAT86-90-□□

Rated luminous flux
60W LED: 6120lm
90W LED: 9200lm
Luminous efficacy: 102lm/W

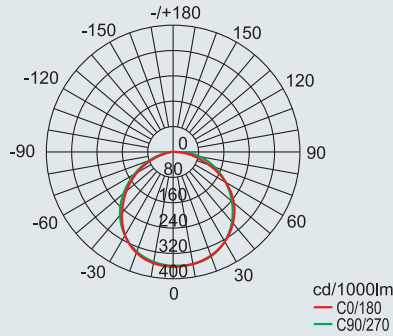

BAT86-90-□□(With 60° lens)

Rated luminous flux
60W LED: 6120lm
90W LED: 9200lm
Luminous efficacy: 102lm/W
Note: Lens of 40° and 25° can be provided on request.

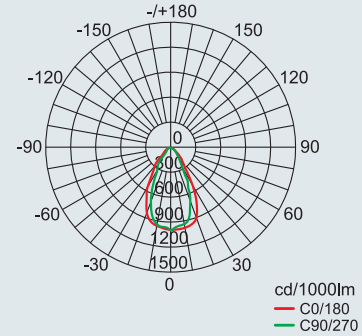

BAT86-160-□□

Rated luminous flux
120W LED: 12200lm
160W LED: 14500lm
Luminous efficacy
120W LED: 102lm/W
160W LED: 91lm/W

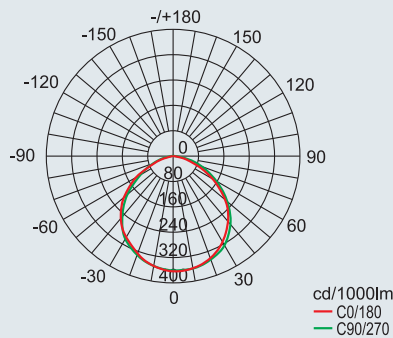

BAT86-160-□□(With 60° lens)

Rated luminous flux
120W LED: 12200lm
160W LED: 14500lm
Luminous efficacy
120W LED: 102lm/W
160W LED: 91lm/W
Note: Lens of 40° and 25° can be provided on request.

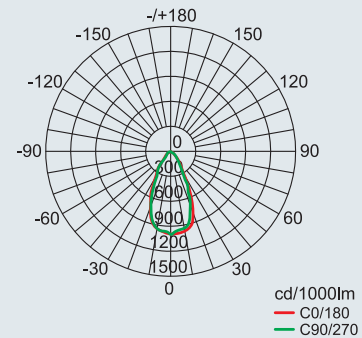

BAT86-240-□□

Rated luminous flux
160W LED: 19250lm
200W LED: 24000lm
240W LED: 28800lm
Luminous efficacy
120W LED: 120lm/W
160W LED: 120lm/W
240W LED: 120lm/W

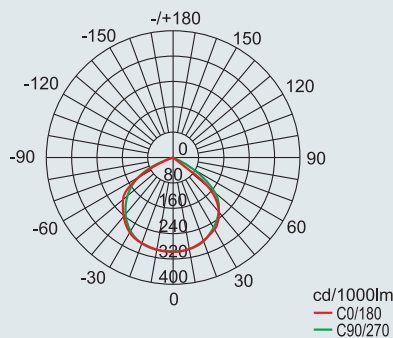

BAT86-240-□□(With 60° lens)

Rated luminous flux
160W LED: 19250lm
200W LED: 24000lm
240W LED: 28800lm
Luminous efficacy
120W LED: 120lm/W
160W LED: 120lm/W
240W LED: 120lm/W
Note: Lens of 40° and 25° can be provided on request.

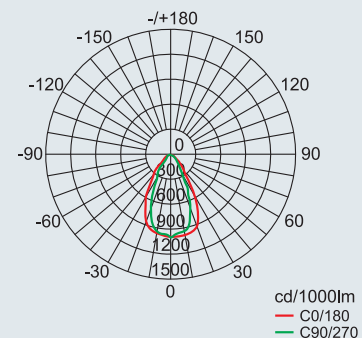

We can provide lighting design and data by professional lighting software DIALUX based upon simulated site situation on request.

LED Light Fittings BAT86 Series Explosion-proof LED Floodlights

Mounting type (all dimensions in mm) - subject to alteration

bracket type

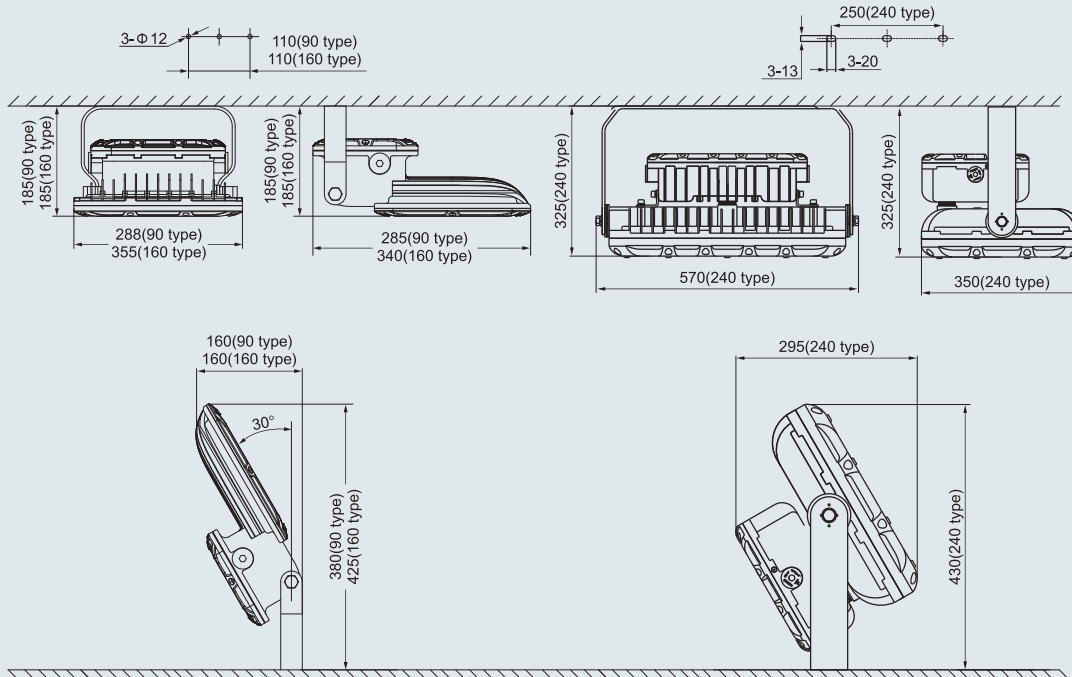

street lamp type

